

Quality products





Contents

The metal of the future	4
Our products	6
Re-melt products	
Purity products	8
Re-melt foundry products	9
Rolling products	10
Billets for forging and extrusion	11
Our quality	12
Service excellence	14
Who we serve	16
Reliable delivery	18
Marketing and Sales team	20
Regional representatives	22
EGA regional offices	23

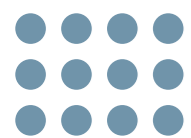

The metal of the future

Emirates Global Aluminium is the largest industrial company in the United Arab Emirates outside oil and gas and was the world's largest 'premium aluminium' producer in 2021.

The most demanding customers rely on us because we have a track record of over four decades in supplying premium aluminium products, with world-class expertise and market insights to help customers achieve a competitive advantage in their markets.

We produce the highest volume of value added products of any company. EGA's product range includes 330 individual products that are made to customer specifications, with most of our aluminium allocated to customers a year in advance. The average purity of EGA's aluminium in 2021 was 99.86 per cent, one of the highest average purities of any company.

Certain pots at our Jebel Ali site in Dubai produce aluminium with an exceptionally high purity of 99.96 per cent, which is used in specialist aviation and electronics applications.

We have 20 casting stations at our smelters in Jebel Ali and Al Taweelah, which gives us significant flexibility to make the products that our customers require to meet their market needs.

We not only supply our customers with the exact aluminium they need, we also help them understand what they need and advise them how they can get the best out of their metal.



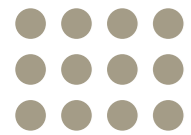

Our products

EGA produces high-quality aluminium products in three main categories:

- High-purity and foundry re-melt products (for electronics and aerospace, as well as automotive applications)
- Rolling products (for packaging, can stock alloys, lithographic sheets and the automotive industry)
- Billets for extrusion and forging (for construction, industrial, transportation and automotive purposes)

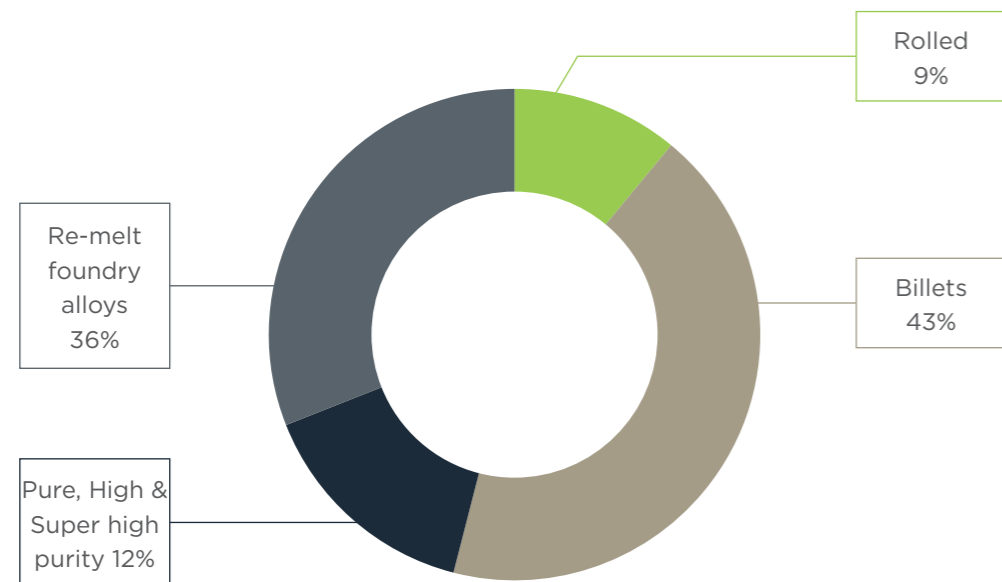

Re-melt product

Super high purity, high purity & standard purity (grade from 99.80%-99.96% purity)	Open mold ingots	10 kg; 20 kg; 22 kg
	Low-profile sow ingots	680 kg
	High-profile sow ingots	500 kg
	Standard profile sow ingots	680 kg

Foundry alloys A356.2, AlSi3Sr, AlSi3Mg, AlSi7Mg, AlSi9Mg, AlSi9MgMn, AlSi10Mg, AlSi10MgMn, AlSi11Mg, AlSiMgCu	HDC small ingots	8 & 10 kg
	T-bars	680 to 1406 kg
	Properzi ingots	10 kg
	Open mould ingots	7, 8, 10, 20 & 22 kg

Rolling product

(1xxx, 3xxx, 5xxx, 6xxx, 8xxx series alloys)	Thickness	600 mm
	Widths	1,150 mm; 1,200 mm; 1,350 mm; 1,400 mm; 1,450 mm; 1,550 mm; 1,600 mm; 1,650 mm; 1,700 mm; 1,750 mm; 1,800 mm; 1,850mm; 1,950 mm; 2,000 mm; 2,050 mm; 2,200 mm
	Lengths	Up to 10,000 mm

Billets for extrusion and forging

(Homogenized using continuous and batch homogenizers)	Diameters available	152 mm; 155 mm; 178 mm; 203 mm; 216 mm; 228 mm; 254 mm; 273 mm; 279 mm; 305 mm; 355 mm; 381 mm; 406 mm
	Lengths	420 mm to 7,500 mm

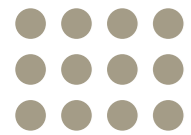

Re-melt products

Purity products

EGA's high-purity aluminium products are used in electronic and aerospace applications, where top quality high-purity aluminium is critical to the successful manufacture of precision parts. They are also used in the manufacture of compact discs, computer hard drives, memory disks, capacitors and other electronic components, in addition to high performance alloys and cathodic protection.

Availability and specifications

Purities:

Ranging from 99.84% to 99.96% aluminium content. Specification can be customised to AA registered P1020, P0507A, P0303A, P0404A, P0304A, P0202A.

Shapes/Forms

Standard Ingots (Jebel Ali)

Weight: **22 kg**
 Dimensions: **738 mm x 174 mm x 112 mm**
 (length x width x height)

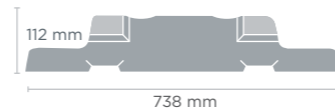

Standard Ingots (Al Taweelah)

Weight: **22 kg**
 Dimensions: **740 mm x 170 mm x 114 mm**
 (length x width x height)

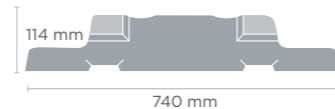

Low Profile Sow Ingots

Weight: **680 kg**
 Dimensions: **1,095 mm x 1,163 mm x 298 mm**
 (length x width x height)

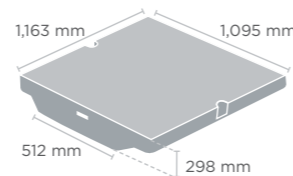

High Profile Sow Ingots

Weight: **500 kg**
 Dimensions: **860 mm x 860 mm x 390 mm**
 (length x width x height)

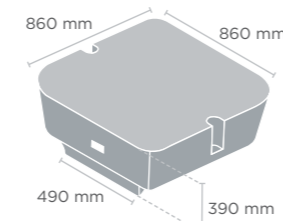

Standard Profile Sow Ingots

Weight: **680 kg**
 Dimensions: **1,110 mm x 1,150 mm x 315 mm**
 (length x width x height)

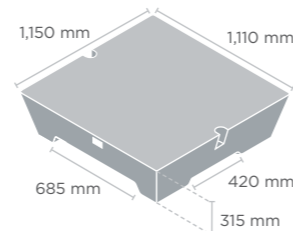

B-Ingots

Weight: **10 kg**
 Dimensions: **730 mm x 105 mm x 75 mm**
 (length x width x height)



Re-melt foundry products

EGA is one of the largest suppliers of foundry alloys to automotive manufacturers. These products are used in the manufacture of wheel rims, sub-frames, and suspension parts, cross members, engine blocks, cylinder heads and engine cradles, among other applications.

Availability and specifications

Alloys:

A356.2, AlSi3Sr, AlSi3Mg, AlSi7Mg, AlSi9Mg, AlSi9MgMn, AlSi10Mg, AlSi10MgMn, AlSi11Mg, AlSiMgCu (available in both Sr modified and unmodified)

Packaging:

Packed in bundles for convenient forklift handling.

Shapes/Forms

Standard Ingots (Jebel Ali)

Weight: **20 kg**
 Dimensions: **736 mm x 171 mm x 107 mm**
 (length x width x height)



Standard Ingots (Al Taweelah)

Weight: **20 kg**
 Dimensions: **735 mm x 170 mm x 113 mm**
 (length x width x height)



B-Ingots

Weight: **10 kg**
 Dimensions: **730 mm x 105 mm x 75 mm**
 (length x width x height)

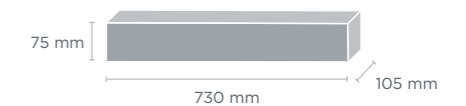

HDC Small Ingots

Weight: **8 kg**
 Dimensions: **756 mm x 54 mm x 75 mm**
 (length x width x height)



HDC Small Ingots

Weight: **10 kg**
 Dimensions: **756 mm x 54 mm x 90 mm**
 (length x width x height)



Properzi Ingots

Weight: **10 kg**
 Dimensions: **730 mm x 105 mm x 53 mm**
 (length x width x height)



T-Ingots

Weight: **680 to 1,406 kg**
 Dimensions: **865 mm x 412 mm**
 (width x height), length sawn to specification (800 mm to 1695 mm)

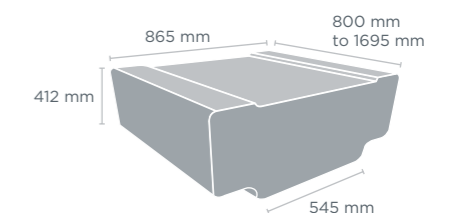

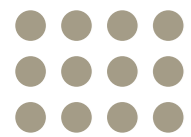

Rolling products

EGA uses state-of-the-art Low Head Composite casting technology. This produces ingots of a very high standard with a superior surface quality, resulting in significant savings for customers in downstream scalping and edge-trimming operations.

EGA sheet ingots are available in a range of sizes and in lengths up to 10 metres. These products are mainly used in the packaging industry (less than 10 microns), can body application and for lithographic plates used in printing.

EGA sheet ingots are also suitable for automotive applications, a growing market as the low density of aluminium makes vehicles lighter, improving fuel efficiency in the process.

Availability and specifications

Alloys:

Series, 1xxx,
3xxx,5xxx,
6xxx,
8xxx

Shapes/Forms

Sheet Ingots

Weight: depends on the dimension

Dimensions: up to 10,000 mm x 1,150 to 2,200mm x 600 mm
(length x width x thickness)

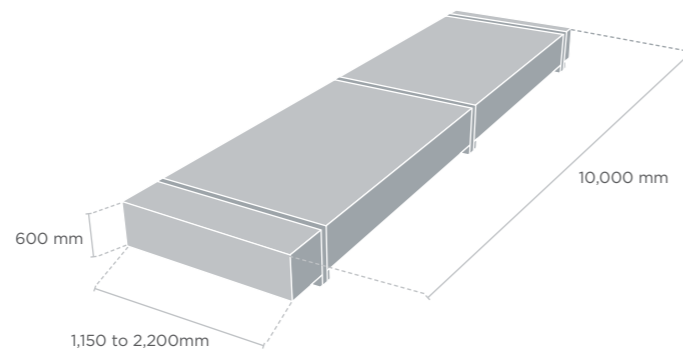

Billets for forging and extrusion

EGA billets are produced using Airslip technology and are ultrasound inspected and homogenised before delivery. A large proportion of our annual production is cast in high extrudability 6063 alloy. These products are used for construction (windows and door frames), transportation, engineering, consumer durables, automotives, forging, as well as many other applications.

Availability and specifications

Alloys:

Produced in common AA alloy series 1000, 3000 and 6000 to customer specifications.

Packaging:

Packed in steel or plastic-strapped bundles on wooden runners for convenient fork-lift handling.

Shapes/Forms

Sheet Ingots

Diameters: 152 mm, 155 mm, 178 mm, 203 mm, 216 mm, 228 mm, 254 mm, 273 mm, 279 mm, 305 mm, 355 mm, 381 mm and 406 mm

Diameter tolerance: ± 1 mm

Billet cut lengths: 420 mm to 7,500 mm

Bow tolerances: 2 mm per meter length of a log

Squareness of cut: 1 mm per 100 mm of the diameter; or 0.5° maximum deviation

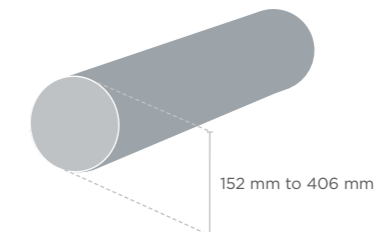

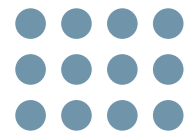

Our quality

EGA products have been verified as suitable for sustainable building practices by two leading internationally-recognised bodies:

- The Leadership in Energy and Environmental Design (LEED) green building program launched by the US Green Building Council
- Deutsche Gesellschaft für Nachhaltiges Bauen e.V. (which translates as the German Sustainable Council), which promotes sustainable and economically efficient building

EGA has focused on continuous improvement across our operations for decades, as the foundation of developing and maintaining global competitiveness. Our international quality standard certifications include:

EGA certifications

Our Al Taweelah and Jebel Ali sites are certified by the Aluminium Stewardship initiative for its sustainability practices and performance. The certification covers EGA's aluminium smelting facilities, including our ports, power generation, carbon plants, potlines and casthouses.

- ISO/IEC 17025:2017 General requirements for competence of testing and calibration laboratories - Abu Dhabi
- ISO/IEC 17025:2017 General requirements for competence of testing and calibration laboratories - Dubai
- ISO 9001: 2015 Casting of Primary Aluminium & Alloys. Manufacture of Carbon Anodes, Power Generation and Water Desalination
- ISO IEC 27001: 2013 Information Security Management System at EGA
- ISO 14001: 2015 Smelting & Casting of Primary Aluminium, manufacture of carbon anodes, power generation and water desalination.
- ISO 45001:2018 Smelting & Casting of Primary Aluminium & its alloys, Manufacture of Carbon Anodes, Power Generation, Water Desalination and Residential Area of Jebel Ali Site.

Al Taweelah certifications

- IATF 16949:2016 Casting Of Primary Aluminium & Alloys

Jebel Ali certifications

- 17020:2012 Accreditation certification for lifting equipment inspection & lifting accessories inspection
- IATF 16949: 2016 Casting Of Primary Aluminium & Alloys



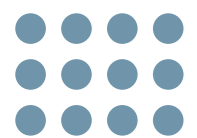

Service excellence

EGA aims to build mutually beneficial long-term relationships with customers. Some 75% of our customers have bought metal from EGA for at least 10 years.

EGA works on innovative projects with customers and academics to develop new alloys, and enable better understanding of the mechanical properties of existing alloys.

We help our customers understand the exact specification of metal they need to meet their performance requirements in the most economically efficient way. We also use our expertise in aluminium to work with customers to help them improve their own manufacturing processes.

Our technical services include:

- Technical support to assess a customer's individual metal requirements, assess processes and offer recommendations and tailor-made services for operational improvements
- Specialist technical guidance on casting and plant start-ups from experienced metallurgical experts who travel to individual markets to deliver technical seminars
- A customer relationship management system that enables customers to track the status of their orders online - from production to distribution
- An efficient customer complaints system, with a guaranteed response within 24 hours



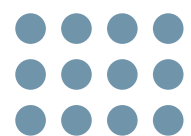

Who we serve

Emirates Global Aluminium supplies primary aluminium to more than 350 customers in over 60 countries around the world. Our key markets are Asia, the Middle East and North Africa region, Europe and the Americas. The main industries we serve are construction, automotive, cans and packaging, and electronics.

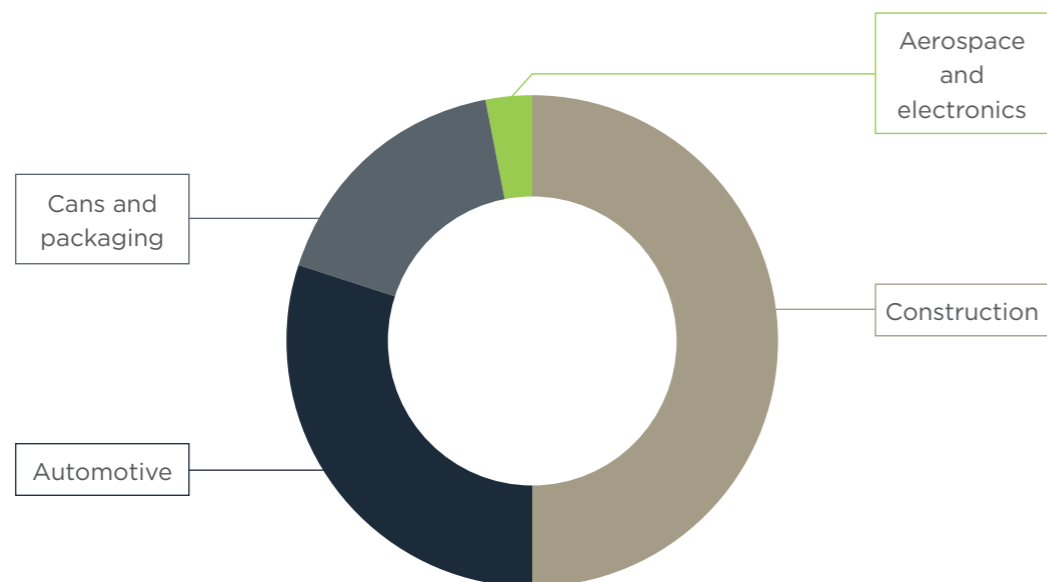

MIDDLE EAST & AFRICA

Algeria
Egypt
Jordan
Lebanon
Morocco
Oman
Palestine
Saudi Arabia
South Africa
Tunisia
Turkey
UAE

FAR EAST & ASIA

China
India
Indonesia
Japan
Malaysia
Pakistan
Philippines
Singapore
South Korea
Sri Lanka
Taiwan
Thailand

EUROPE

Albania
Austria
Belgium
Bosnia-Herzegovina
Bulgaria
Cyprus
Czech Republic
Finland
France
Germany
Greece
Hungary
Ireland
Italy
Netherlands
Poland
Portugal
Romania
San Marino
Slovenia
Spain
Sweden
Switzerland
United Kingdom

AMERICAS

Brazil
El Salvador
Mexico
Trinidad/Tobago
USA
Uruguay

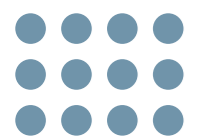

Reliable delivery

Our aluminium supply is underpinned by a comprehensive global logistics operation. We make over 10,000 shipments per year, in over 100,000 containers.

EGA uses 20 different shipping lines to ship aluminium to over 70 global ports. Just within the United Arab Emirates, our product shipments account for 90,000 truck movements each year between our smelters, UAE ports and domestic customers.

Our delivery reliability, based on a comparison with global shipping figures, is world class.



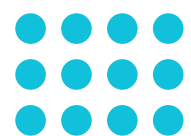

Marketing and Sales Team

EGA has a network of marketing offices and trusted partners across the globe to serve our customers.

Adel Abubakar
Chief Marketing Officer

Emirates Global Aluminium PJSC
P O Box 3627, Dubai
United Arab Emirates

**FOR GENERAL ENQUIRY TO
OUR MARKETING AND SALES,
PLEASE CONTACT:**

T +971 4 822 1000
E sales@ega.ae

EUROPE

Raid Malalla
Senior Director, Marketing & Sales
Europe

Emirates Global Aluminium PJSC
P O Box 3627, Dubai
United Arab Emirates
D +971 4 822 3842
M +971 50 653 4890
E rmohamed@ega.ae

Faisal Sarhan
Senior Manager, Marketing & Sales
Europe

Emirates Global Aluminium PJSC
P O Box 3627, Dubai
United Arab Emirates
D +971 4 822 3160
M +971 56 188 2429
E fsarhan@ega.ae

Khaled AlShehhi
Manager, Marketing & Sales
Europe

Emirates Global Aluminium PJSC
P O Box 3627, Dubai
United Arab Emirates
D +971 4 822 6202
M +971 50 472 7176
E khaalshehhi@ega.ae

MIDDLE EAST

Abdulla Saif
Senior Director, Marketing & Sales
GCC, Middle East, Africa & Indian
Sub-Continent

Emirates Global Aluminium PJSC
P O Box 3627, Dubai
United Arab Emirates
D +971 4 822 2121
M +971 50 625 2840
E asaif@ega.ae

Abdelwahid Al Marzouqi
Senior Manager, Marketing & Sales
GCC

Emirates Global Aluminium PJSC
P O Box 3627, Dubai
United Arab Emirates
D +971 4 822 2722
M +971 50 644 0667
E aabdelrahman@ega.ae

Ibrahim Al Farsi
Manager, Marketing & Sales -
Middle East, Africa & Indian Sub-Continent

Emirates Global Aluminium PJSC
P O Box 3627, Dubai
United Arab Emirates
D +971 4 822 2860
M +971 50 625 9616
E ial-farsi@ega.ae

ASIA

Mohammad Qanbar
Senior Director, Marketing & Sales
Asia

Emirates Global Aluminium PJSC
P O Box 3627, Dubai
United Arab Emirates
D +971 4 822 2307
M +971 50 655 1264
E mqanbar@ega.ae

Mansoor Al Boom
Manager, Marketing & Sales
Asia

Emirates Global Aluminium PJSC
P O Box 3627, Dubai
United Arab Emirates
D +971 4 822 1477
M +971 50 764 8686
E malboom@ega.ae

Ayoob Al Hammadi
Associate, Marketing & Sales
Asia

Emirates Global Aluminium PJSC
P O Box 3627, Dubai
United Arab Emirates
D +971 4 822 3474
M +971 50 514 4484
E ayalhammadi@ega.ae

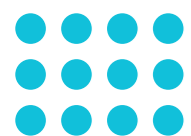

Regional Representatives

Chavalit Kumar (Jimmy) Thailand

Win Global Metal Co., Ltd.
46/163 M12, M. Sureeporn,
Nuanchan Road, T. Klongkum,
A. Buengkum, Bangkok 10230,
Thailand
T +662 363 4414 / 15 / 16
F +662 944 4579
E jimmy@winglobalmetal.com

Phoebe Ross Singapore

United States Trading Co., Pte Ltd.
19 Tanglin Road # 09-04
Tanglin Shopping Centre
Singapore 247909
T +65 6235 4000
F +65 6734 6808
E pross@ustrading.com.sg

Nelson Yen Malaysia

Universal Sejati (M) Sdn Bhd
9-2 1st floor, Jalan SS 23/11
Taman S.E.A, 47400 Petaling Jaya
Selangor Darul Ehsan
Malaysia
T +603 7803 2820
F +603 7803 2871 / 2877
E nelsonyen@ustrading.com.my

Mac Yim Indonesia

P.T. Adireksa Sentosa Jaya
Grand ITC Permata Hijau,
Lantai 8 Suite A1-2,
Jl.Arteri Permata Hijau,
Jakarta 12210
Indonesia
T +62 21 5366 4380
F +62 21 5366 0196
operations_dubal@adireksa.com

Keishiro Kitamura Japan

ITOCHU Corporation:
Light Metal Raw Materials Section
5-1, Kita Aoyama 2-Chome
Minato-Ku
Tokyo 107-8077, Japan
T +81334973931
F +81334973341
E toknl-sales@itochu.co.jp

Catrina Fragante Philippines

Tradcon
Unit 707 One Park Drive
11th Drive, Corner 9th Ave
Taguig, 1634 Metro Manila
Philippines
T +639203052025
E tradcon@icloud.com

Jackson Wang **Jimmy Wang** **Stella Chen** Taiwan/China

Ever Capital International Limited
1F, No. 33-1, Fu Shun Street
Taipei 10452
Taiwan
T +886 2 2595 5877
F +886 2 2595 5857
E ever@mustmetal.com.tw



EGA Regional Offices

Jake Skelton Chief Executive Officer EGA America Inc.

3 Cityplace Dr., Suite 600
St. Louis, MO 63141
USA
T +1 314 596 9229
D +1 314 596 9225
M +1 314 753 5253
E jskelton@egaamerica.com

Charlie Park Emirates Global Aluminium Korea Ltd.

Suit 1105 Kosmo Tower, Daechi-dong
Kangnam-gu, Seoul,
South Korea
T +822 2052 3500 / 3501
F +822 2052 3502
M +82 10 3253 3556
E charlie@egakorea.com

Joachim Haas Managing Director EGA Europe AG

EGA Europe AG
Seefeldstrasse 45
CH-8008 Zurich
Switzerland
T +41 43 456 3800
D +41 43 456 3801
M +41 79 307 3852
E jshaas@ega.ae

EGA EU Imports S.r.l

Via San Luca 10, I-20122
Milan
Italy

FOR ADDITIONAL INFORMATION, CONTACT

Emirates Global Aluminium PJSC (EGA)
P O Box 3627, Dubai, United Arab Emirates
T +971 4 822 1000
E sales@ega.ae

 Emirates Global Aluminium

 emiratesglobalaluminium

 Emirates Global Aluminium

 egaofficial

 www.ega.ae

